



# 627C/628C SERIES



## Power Combo D-Sub Connectors: Vertical

### Layout:

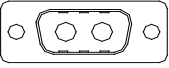
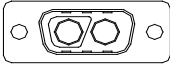
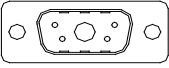
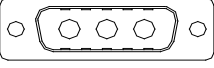
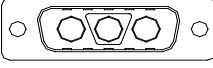
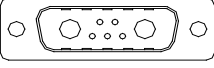
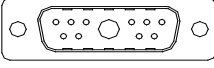
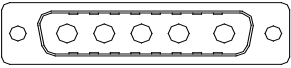
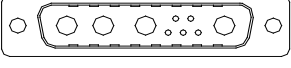
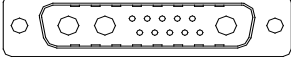
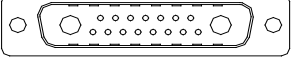
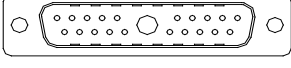
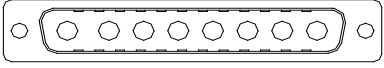
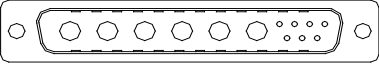
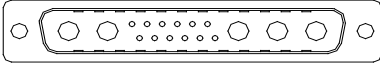
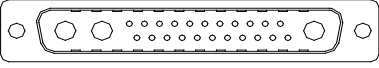
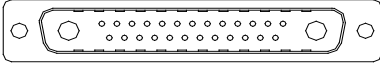
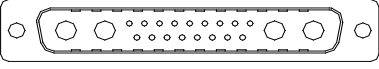
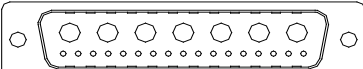
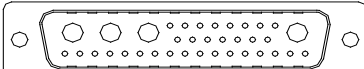
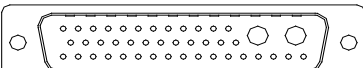
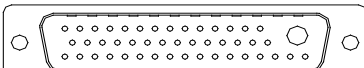
	POWER/COAXIAL D-SUB ONLY	COMBINATION
SIZE 9	 2W2  2WK2	 5W1
SIZE 15	 3W3  3WK3	 7W2  11W1
SIZE 25	 5W5	 9W4  13W3  17W2  21W1
SIZE 37	 8W8	 13W6  17W5  25W3  27W2  21W4
SIZE 50		 24W7  36W4  43W2  47W1

# 627C/628C SERIES



## Power Combo D-Sub Connectors: Vertical

### STRAIGHT PCB TYPE MOUNTING OPTION

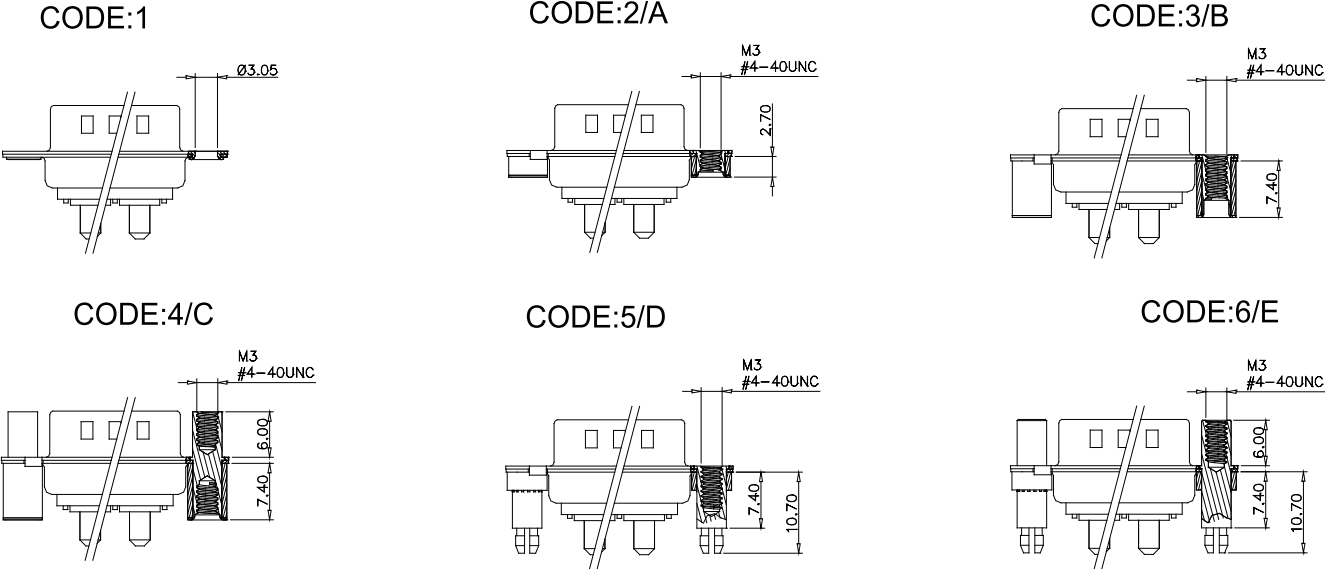

### PCB LAYOUT FOR POWER D-SUB MALE AND FEMALE CONNECTOR

CODE:2W2/2WK2

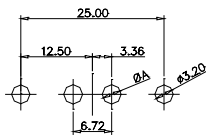

CODE:3W3/3WK3

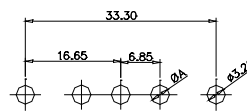

CODE:5W5 MALE

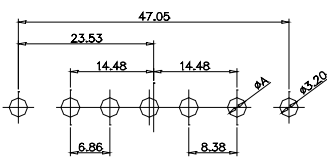

CODE:8W8 MALE

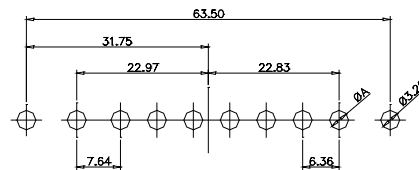

CODE:5W5 FEMALE

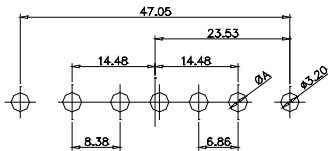

CODE:8W8 FEMALE

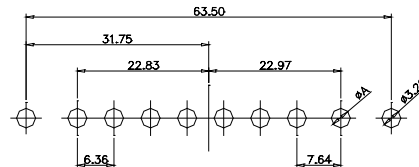

CURRENT RATING	10A	20A	30A	40A
ØA(mm)	2.2	3.3	3.7	4.2

# 627C/628C SERIES



## Power Combo D-Sub Connectors: Vertical

### Power/Coaxial D-SUB

#### STRAIGHT PCB TYPE MOUNTING OPTION

CODE:1

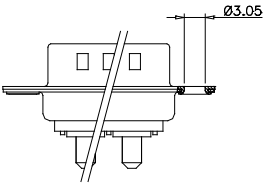

CODE:2/A

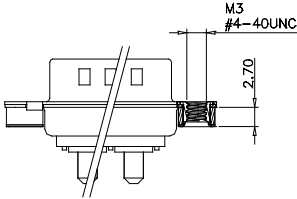

CODE:3/B

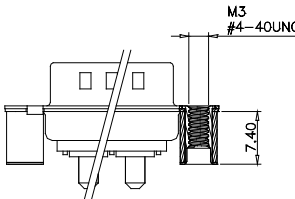

CODE:4/C

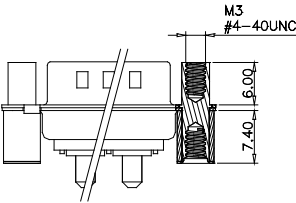

CODE:5/D

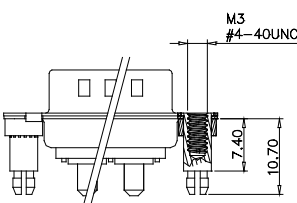

CODE:6/E

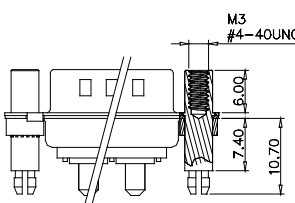

#### PCB LAYOUT FOR POWER D-SUB MALE AND FEMALE CONNECTOR

CODE:2W2/2WK2

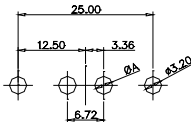

CODE:3W3/3WK3

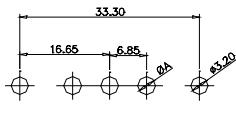

CODE:5W5 MALE

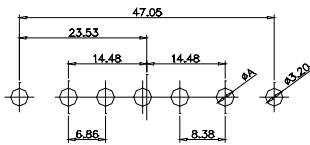

CODE:8W8 MALE

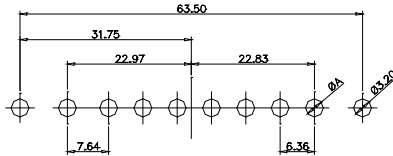

CODE:5W5 FEMALE

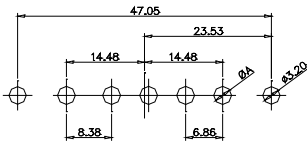

CODE:8W8 FEMALE

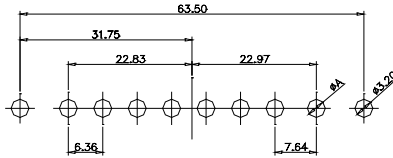

CURRENT RATING	10A	20A	30A	40A
ØA(mm)	2.2	3.3	3.7	4.2

# 627C/628C SERIES



## Power Combo D-Sub Connectors: Vertical

### PCB LAYOUT FOR COAXIAL D-SUB MALE AND FEMALE CONNECTOR

CODE:2W2/2WK2

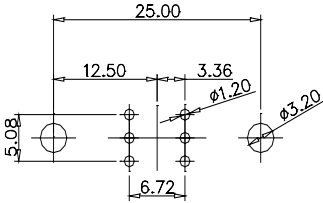

CODE:3W3/3WK3

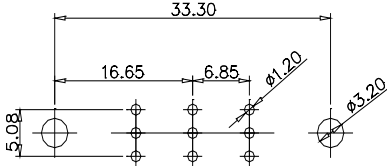

CODE:5W5 MALE

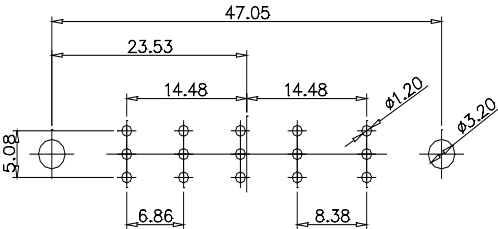

CODE:8W8 MALE

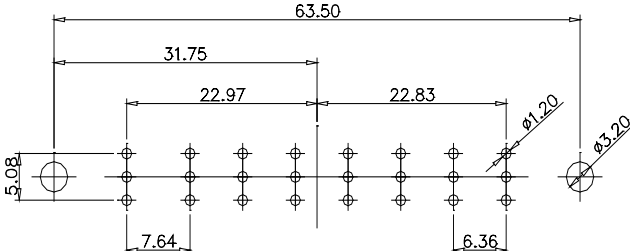

CODE:5W5 FEMALE

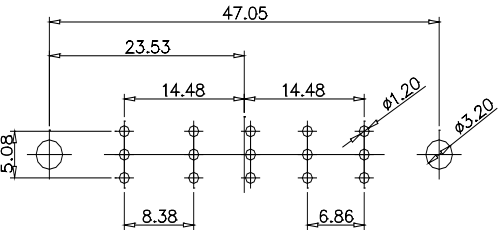

CODE:8W8 FEMALE

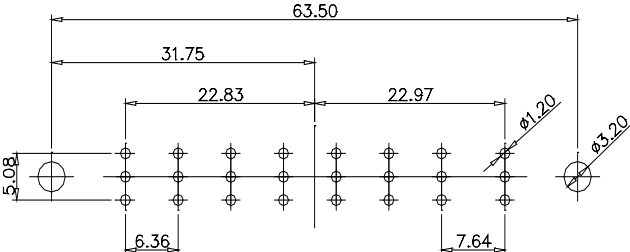

# 627C/628C SERIES



## Power Combo D-Sub Connectors: Vertical

### SOLDER CUP TYPE

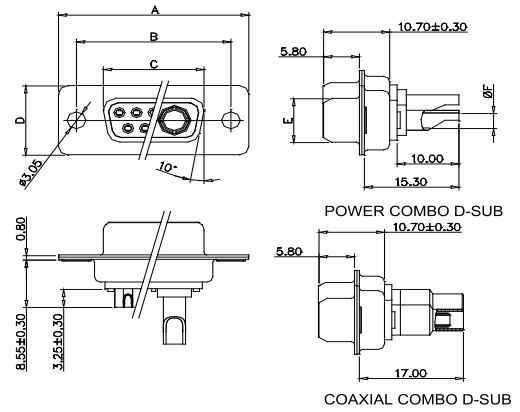
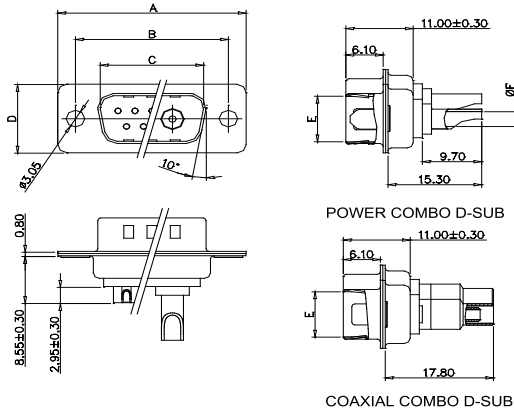

POWER D-SUB							
CONTACT SHELL SIZE	DIMA	DIMB	DIMC	DIMD	DIME	RATING	ØF
SIZE 9	30.80	25.00	16.90	12.50	8.30	10A	1.7
SIZE 15	39.20	33.30	25.25	12.50	8.30	20A	2.7
SIZE 25	53.05	47.05	38.95	12.50	8.30	30A	3.5
SIZE 37	69.40	63.50	55.40	12.50	11.15	40A	4.6
SIZE 50	67.00	61.00	52.80	15.30	11.15		
COAXIAL D-SUB							

POWER D-SUB							
CONTACT SHELL SIZE	DIMA	DIMB	DIMC	DIMD	DIME	RATING	ØF
SIZE 9	30.80	25.00	16.30	12.50	7.90	10A	1.7
SIZE 15	39.20	33.30	24.60	12.50	7.90	20A	2.7
SIZE 25	53.05	47.05	38.40	12.50	7.90	30A	3.5
SIZE 37	69.40	63.50	54.80	12.50	7.90	40A	4.6
SIZE 50	67.00	61.00	52.20	15.30	10.90		
COAXIAL D-SUB							

### STRAIGHT PCB TYPE

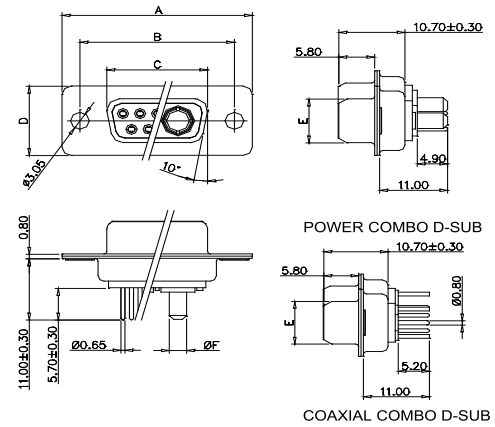
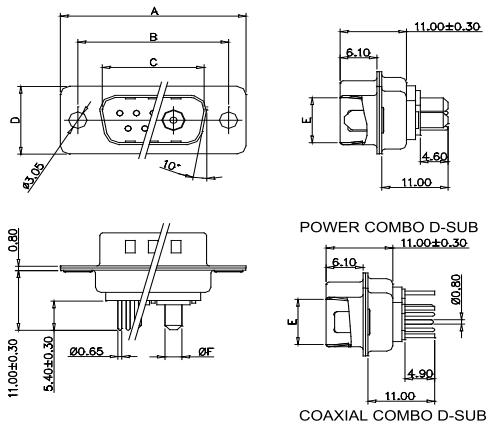

POWER D-SUB							
CONTACT SHELL SIZE	DIMA	DIMB	DIMC	DIMD	DIME	RATING	ØF
SIZE 9	30.80	25.00	16.90	12.50	8.30	10A	1.7
SIZE 15	39.20	33.30	25.25	12.50	8.30	20A	2.8
SIZE 25	53.05	47.05	38.95	12.50	8.30	30A	3.2
SIZE 37	69.40	63.50	55.40	12.50	11.15	40A	3.75
SIZE 50	67.00	61.00	52.80	15.30	11.15		
COAXIAL D-SUB							

POWER D-SUB							
CONTACT SHELL SIZE	DIMA	DIMB	DIMC	DIMD	DIME	RATING	ØF
SIZE 9	30.80	25.00	16.30	12.50	7.90	10A	1.7
SIZE 15	39.20	33.30	24.60	12.50	7.90	20A	2.8
SIZE 25	53.05	47.05	38.40	12.50	7.90	30A	3.2
SIZE 37	69.40	63.50	54.80	12.50	7.90	40A	3.75
SIZE 50	67.00	61.00	52.20	15.30	10.90		
COAXIAL D-SUB							

### SOLDER CUP TYPE MOUNTING OPTION

CODE:1

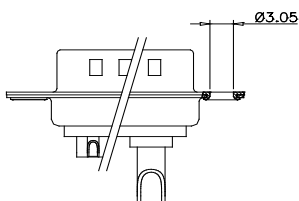

CODE:A

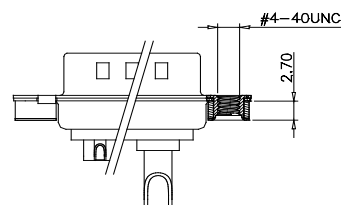

# 627C/628C SERIES



## Power Combo D-Sub Connectors: Vertical

### Power & Coaxial Combo D-SUB

#### STRAIGHT PCB TYPE MOUNTING OPTION

CODE:1

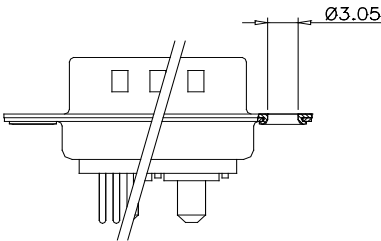

CODE:2/A

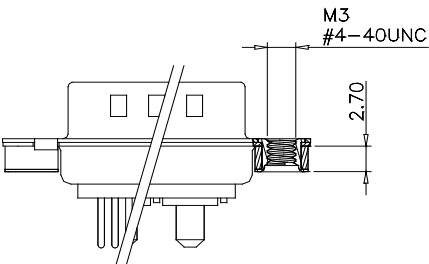

CODE:3/B

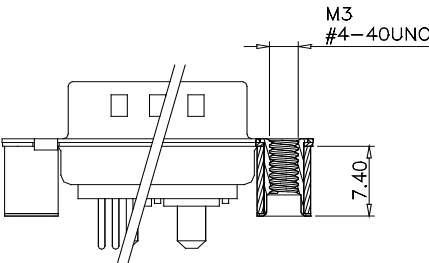

CODE:4/C

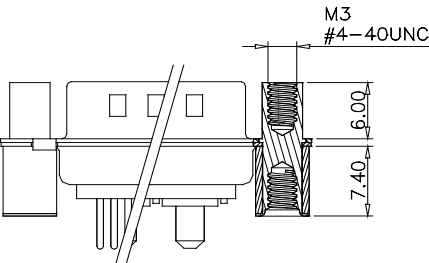

CODE:5/D

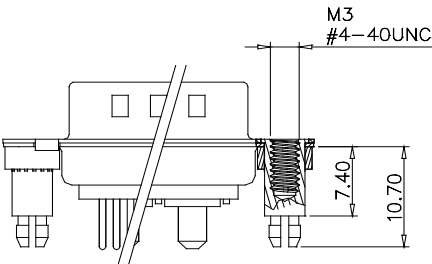

CODE:6/E

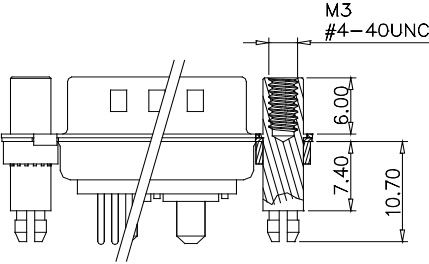

# 627C/628C SERIES



## Power Combo D-Sub Connectors: Vertical

### Power Combo D-SUB

### PCB LAYOUT FOR MALE AND FEMALE CONNECTOR

CODE:5W1  
MALE/FEMALE

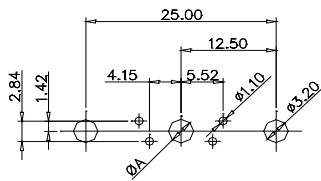

CODE:24W7  
MALE/FEMALE

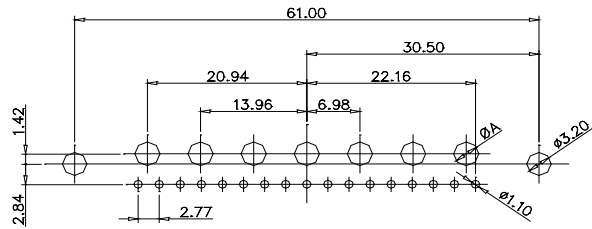

CODE:7W2  
MALE/FEMALE

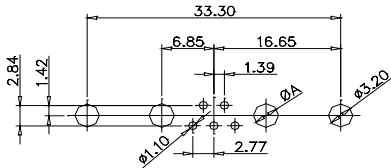

CODE:21W4  
MALE/FEMALE

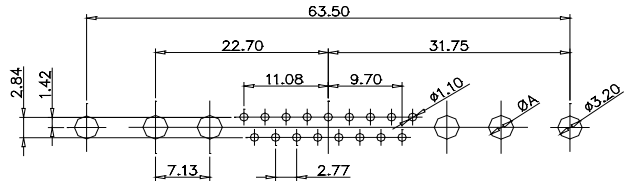

CODE:11W1  
MALE/FEMALE

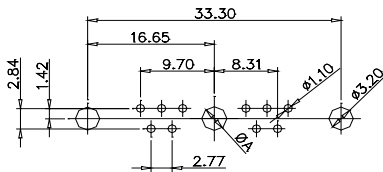

CODE:27W2  
MALE/FEMALE

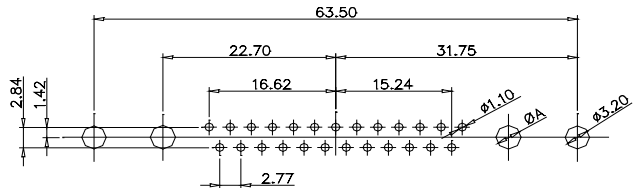

CODE:17W2  
MALE/FEMALE

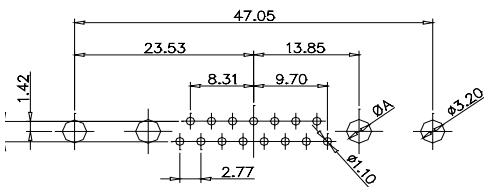

CODE:21W1  
MALE/FEMALE

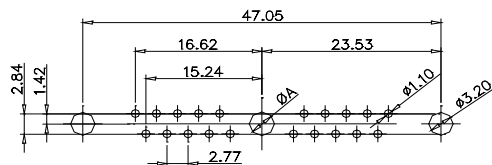

CURRENT RATING	10A	20A	30A	40A
ØA(mm)	2.2	3.3	3.7	4.2



# 627C/628C SERIES



## Power Combo D-Sub Connectors: Vertical

### Power Combo D-SUB

#### PCB LAYOUT FOR MALE CONNECTOR

CODE:9W4  
MALE

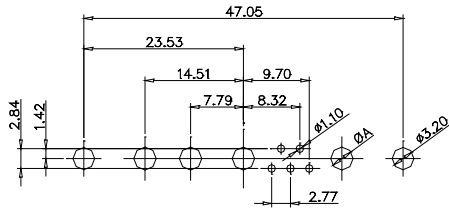

CODE:25W3  
MALE

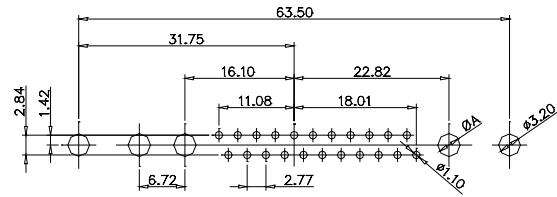

CODE:13W3  
MALE

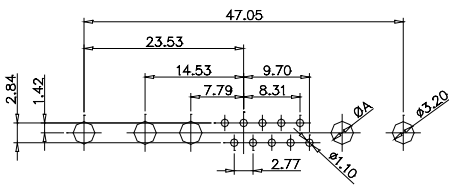

CODE:36W4  
MALE

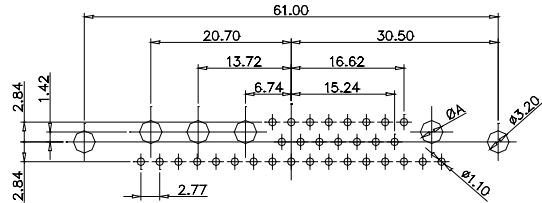

CODE:13W6  
MALE

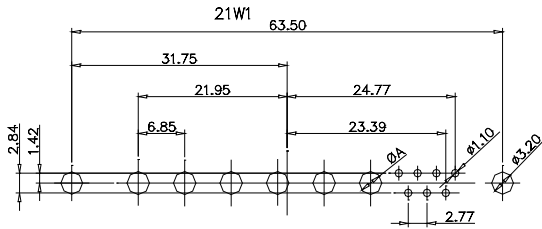

CODE:43W2  
MALE

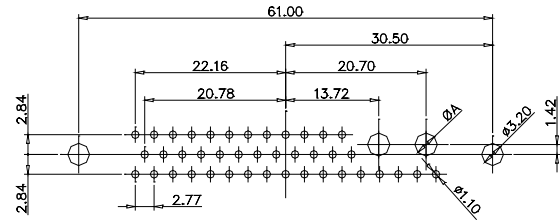

CODE:17W5  
MALE

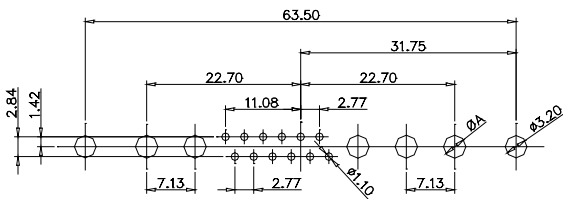

CODE:47W1  
MALE

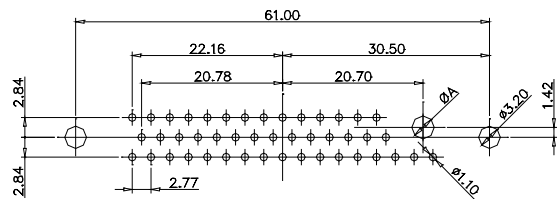

CURRENT RATING	10A	20A	30A	40A
ØA(mm)	2.2	3.3	3.7	4.2

# 627C/628C SERIES



## Power Combo D-Sub Connectors: Vertical

### Power Combo D-SUB

### PCB LAYOUT FOR FEMALE CONNECTOR

CODE:9W4  
FEMALE

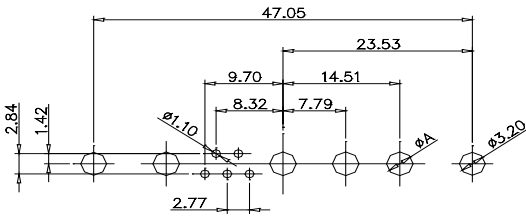

CODE:25W3  
FEMALE

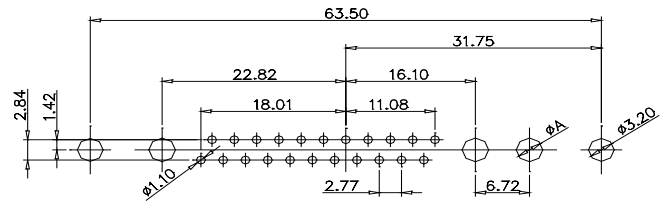

CODE:13W3  
FEMALE

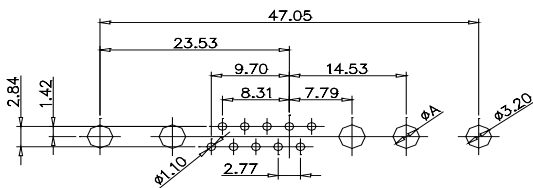

CODE:36W4  
FEMALE

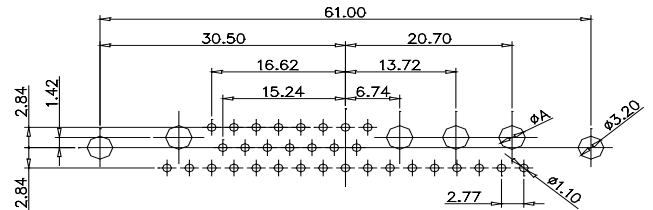

CODE:13W6  
FEMALE

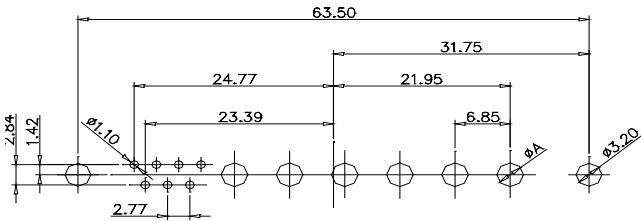

CODE:43W2  
FEMALE

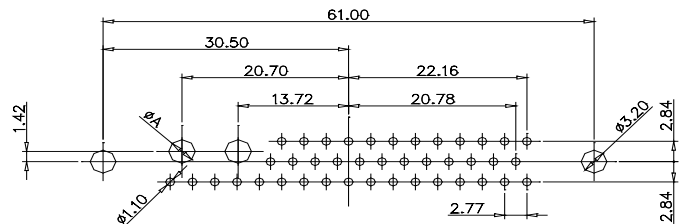

CODE:17W5  
FEMALE

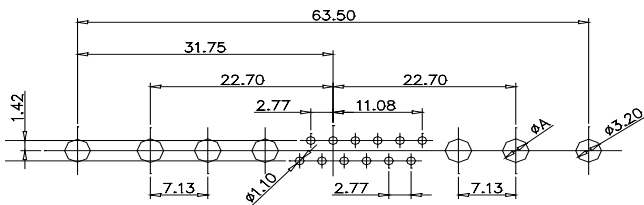

CODE:47W1  
FEMALE

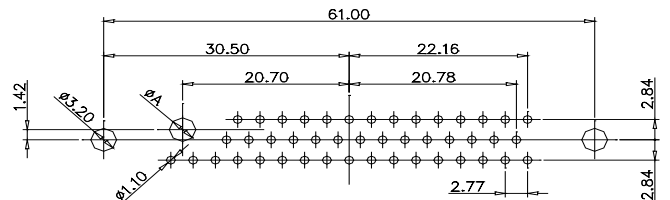

CURRENT RATING	10A	20A	30A	40A
$\phi A(mm)$	2.2	3.3	3.7	4.2

# 627C/628C SERIES



## Power Combo D-Sub Connectors: Vertical

### STRAIGHT PCB TYPE MOUNTING OPTION

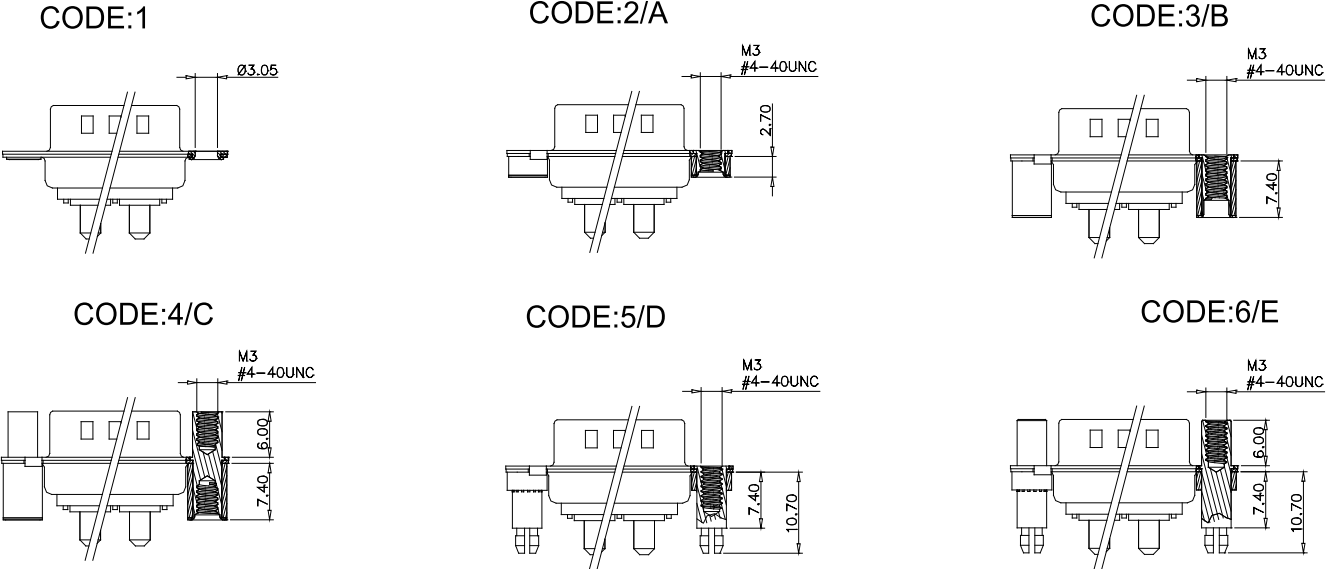

### PCB LAYOUT FOR POWER D-SUB MALE AND FEMALE CONNECTOR

CODE:2W2/2WK2

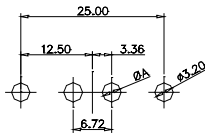

CODE:3W3/3WK3

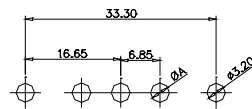

CODE:5W5 MALE

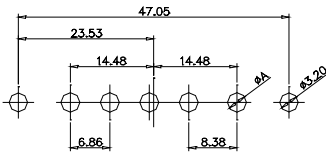

CODE:8W8 MALE

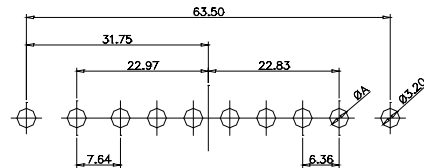

CODE:5W5 FEMALE

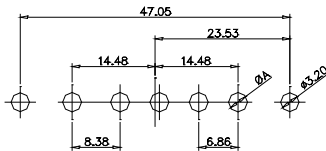

CODE:8W8 FEMALE

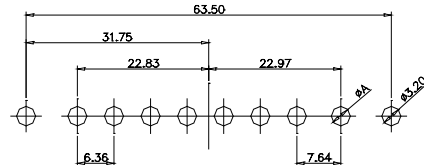

CURRENT RATING	10A	20A	30A	40A
$\varnothing A(\text{mm})$	2.2	3.3	3.7	4.2

# 627C/628C SERIES



## Power Combo D-Sub Connectors: Vertical

### Coaxial Combo D-SUB

5W1 Male/Female

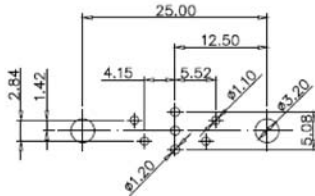

24W7 Male/Female

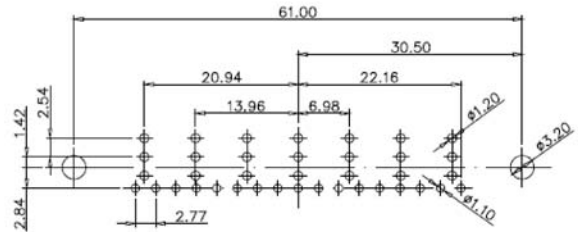

7W2 Male/Female

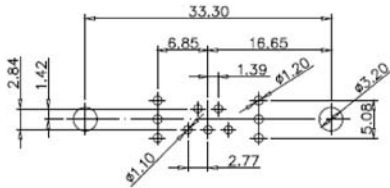

21W4 Male/Female

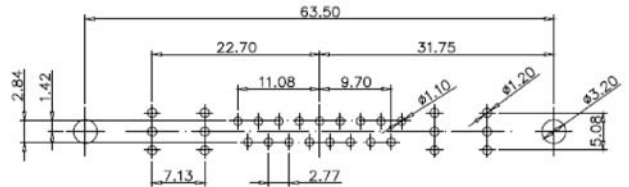

11W1 Male/Female

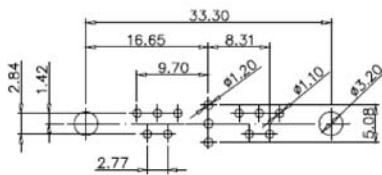

27W2 Male/Female

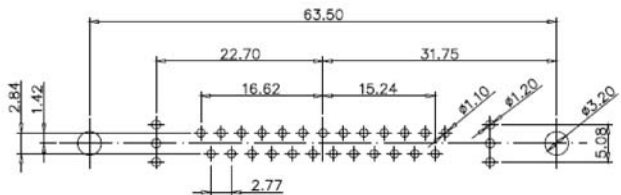

17W2 Male/Female

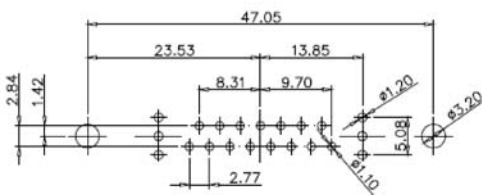

21W1 Male/Female

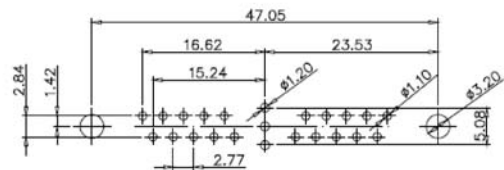

# 627C/628C SERIES



## Power Combo D-Sub Connectors: Vertical

### Coaxial Combo D-SUB

9W4 Male

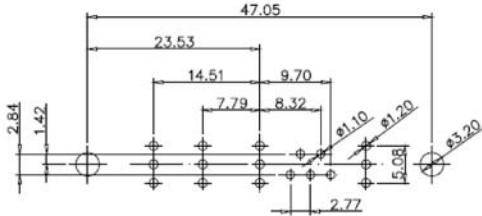

25W3 Male

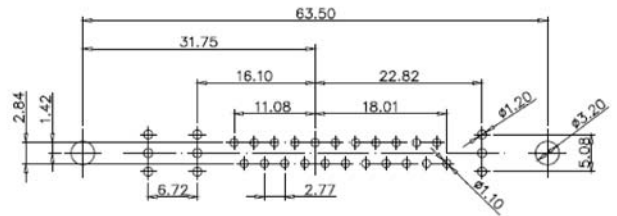

13W3 Male

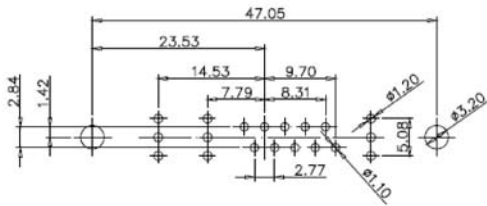

36W4 Male

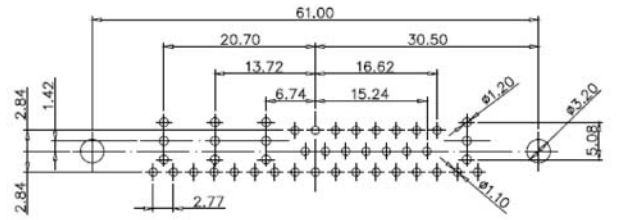

13W6 Male

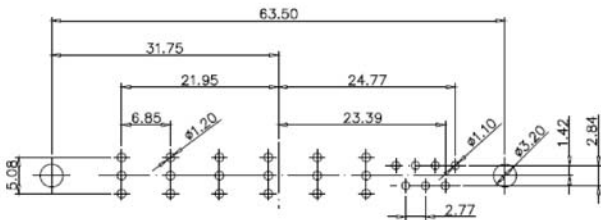

43W2 Male

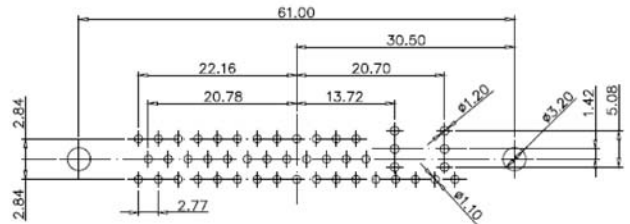

17W5 Male

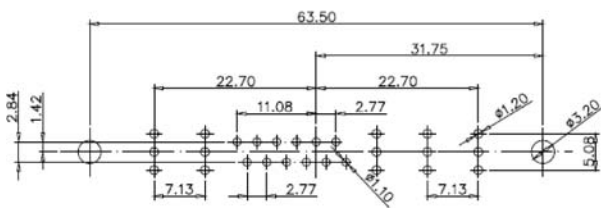

47W1 Male

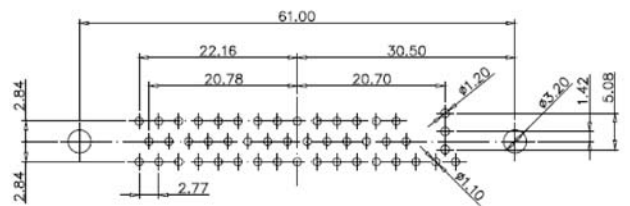

# 627C/628C SERIES



## Power Combo D-Sub Connectors: Vertical

### Coaxial Combo D-SUB

9W4 Female

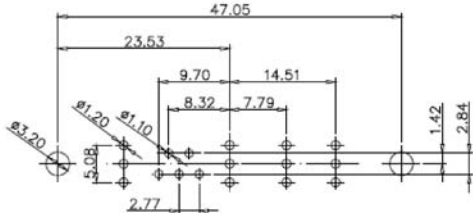

25W3 Female

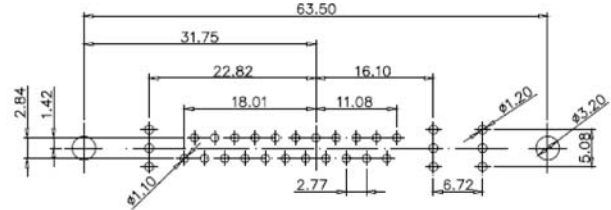

13W3 Female

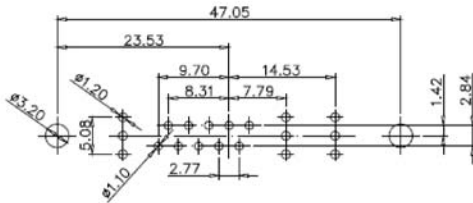

36W4 Female

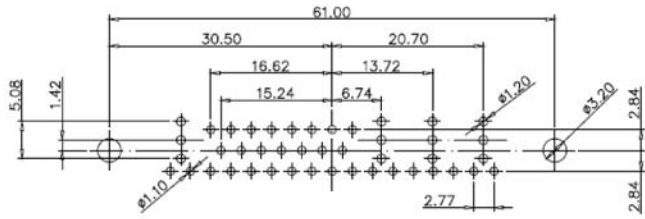

13W6 Female

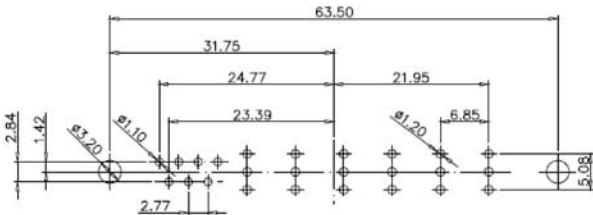

43W2 Female

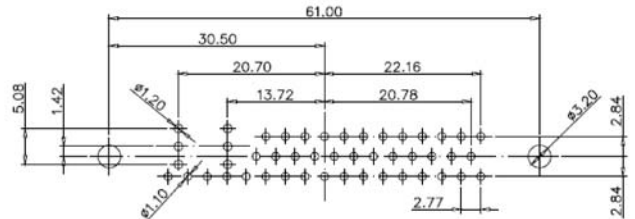

17W5 Female

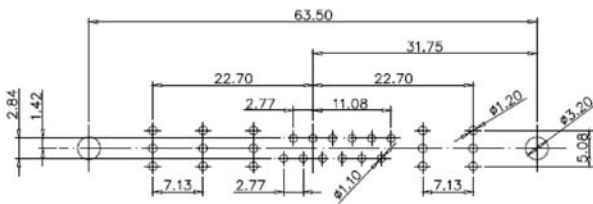

47W1 Female

